

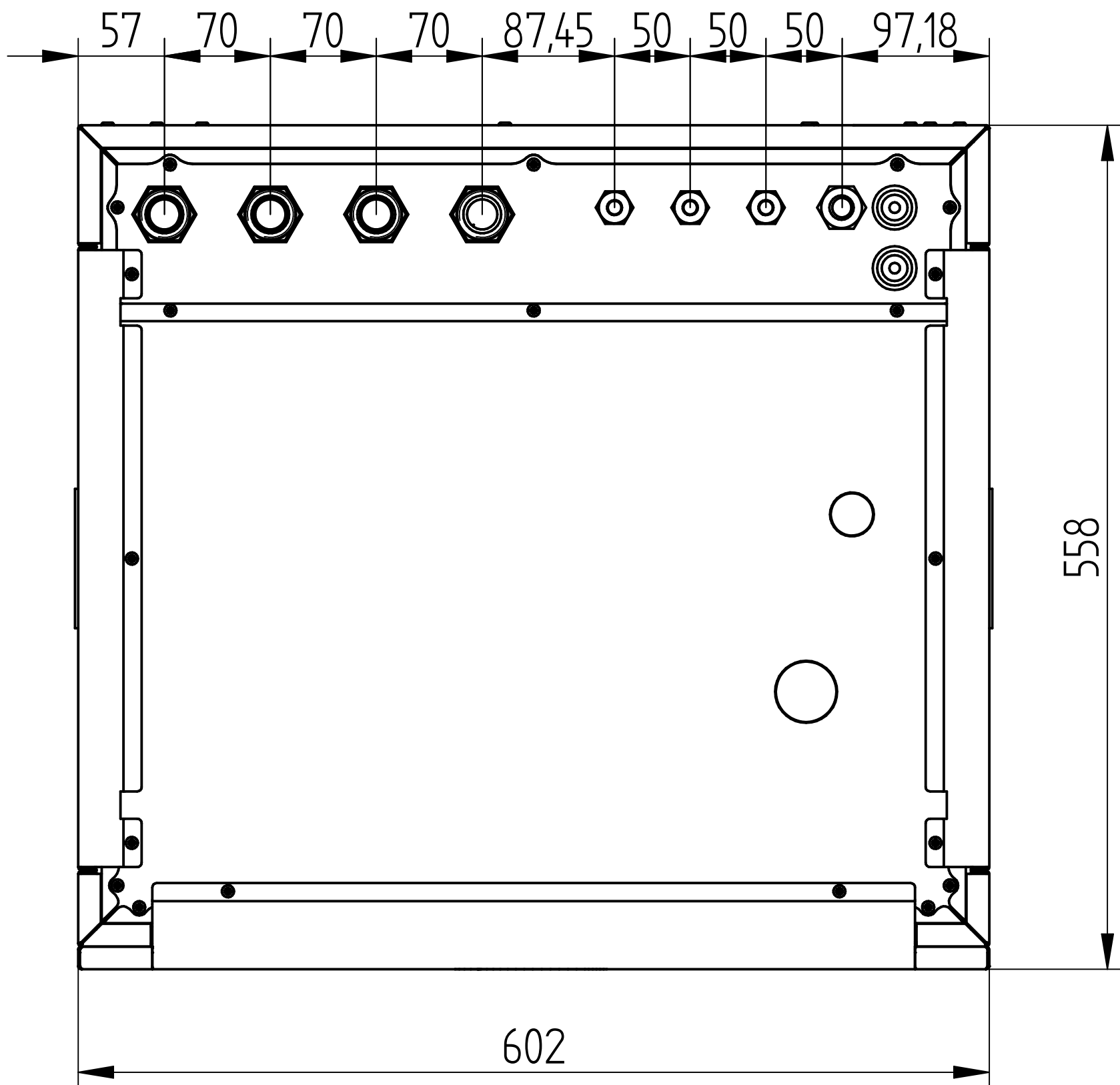

 Thermics energie www.thermics-energie.it E-mail: info@thermics-energie.it						
				DESCRIZIONE						
				Dimensionali DURAN 8-12 kW_4TS_UI_Rev.05						
				CODICE		REV				
				7T03xx4M2xx05		05				
				NOME		DATA				
				DISEGNATO ANDREA C.		21/12/2023				
				APPROVATO ANDREA C.		21/12/2023				
N.	DATA	DESCRIZIONE	FIRMA	TOLLERANZE		MISURE	ANGOLI NON QUOTATI	SCALA	FORMATO	FOGLIO
/	/	/		ISO 2768 mK		mm	90°	1:10	A3	1 / 4



				 Thermics energie www.thermics-energie.it E-mail: info@thermics-energie.it					
				DESCRIZIONE					
				Dimensionali DURAN 8-12 kW_4TS_UI_Rev.05					
				CODICE		REV			
				7T03xx4M2xx05		05			
				NOME		DATA			
				DISEGNATO ANDREA C.		21/12/2023			
				APPROVATO ANDREA C.		21/12/2023			
N.	DATA	DESCRIZIONE	FIRMA	TOLLERANZE	MISURE	ANGOLI NON QUOTATI	SCALA	FORMATO	FOGLIO
/	/	/		ISO 2768 mK	mm	90°	1:1	A3	2 / 4

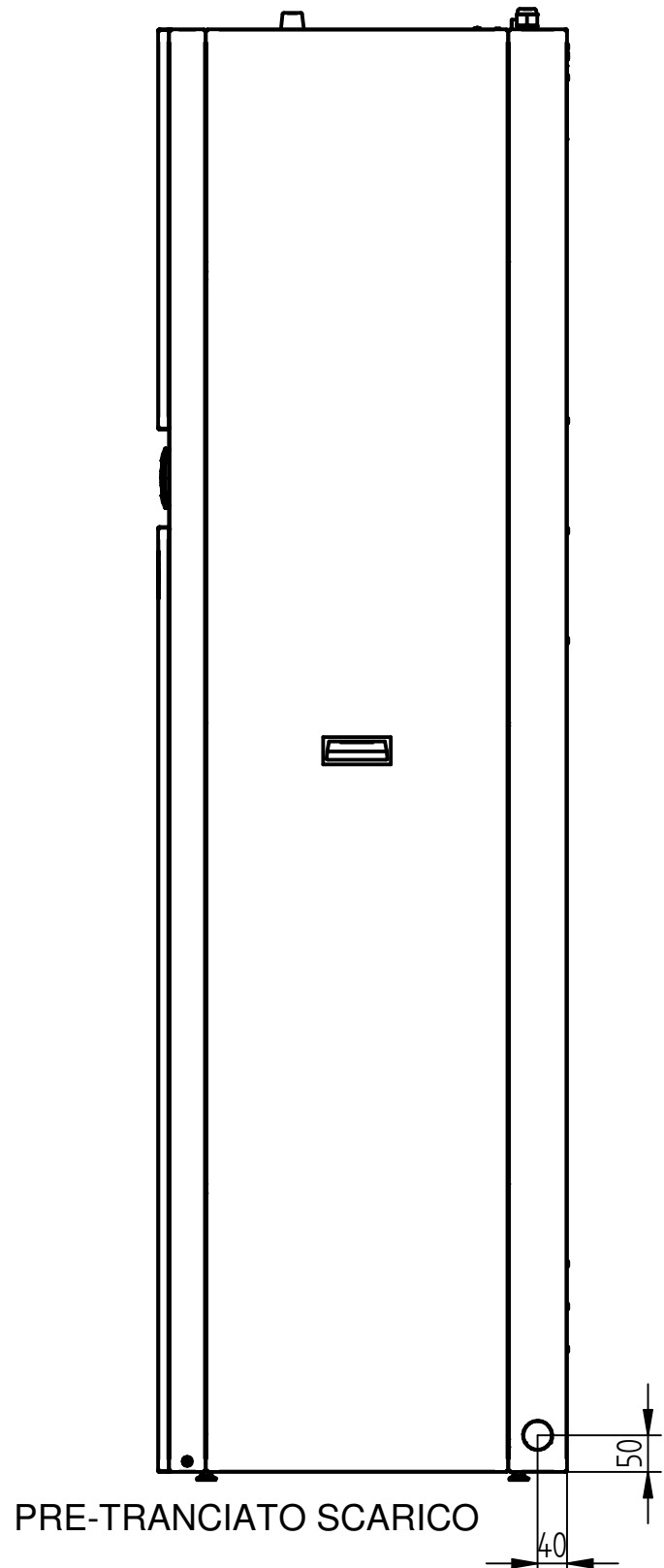
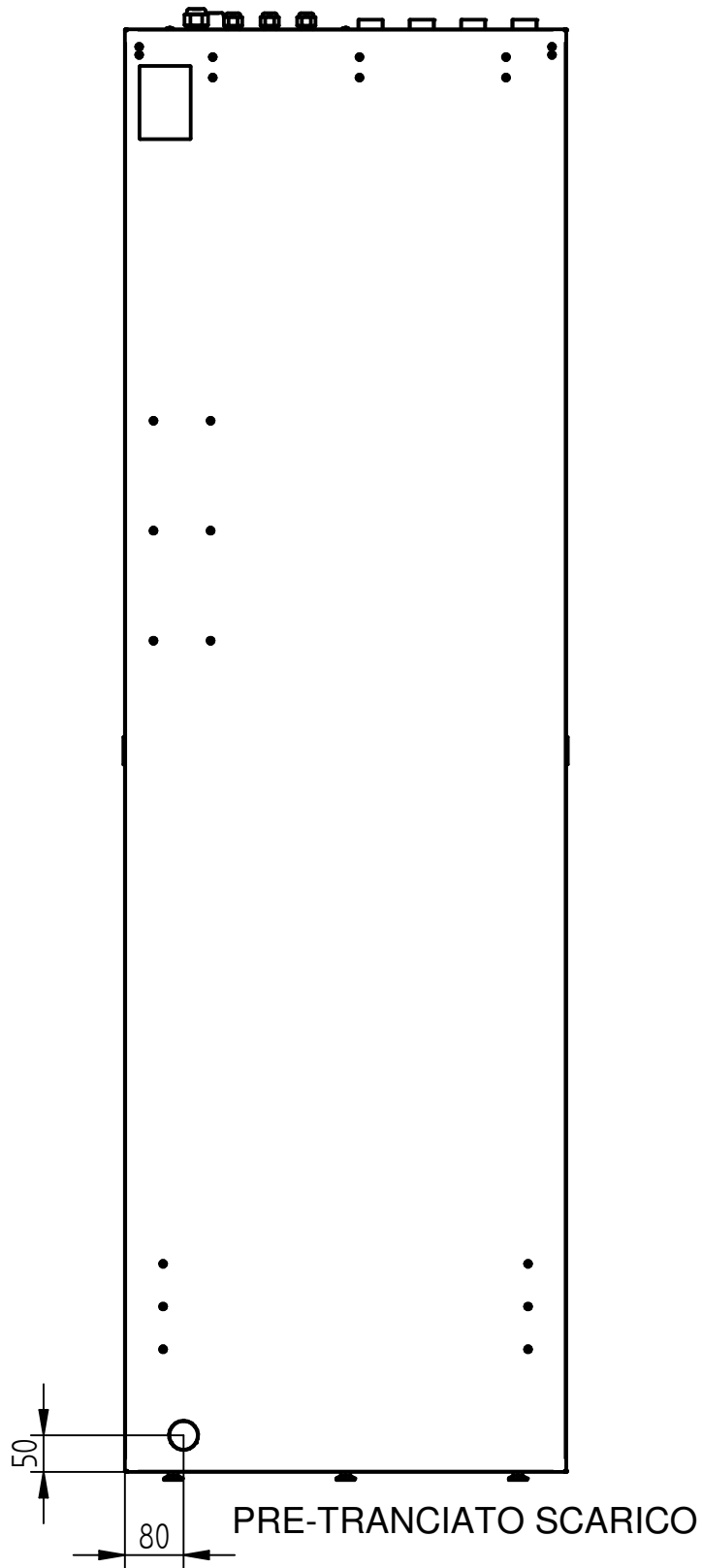

				 Thermics energie www.thermics-energie.it E-mail: info@thermics-energie.it						
				DESCRIZIONE						
				Dimensionali DURAN 8-12 kW_4TS_UI_Rev.05						
				CODICE		REV				
				7T03xx4M2xx05		05				
				NOME		DATA				
				DISEGNATO ANDREA C.		21/12/2023				
				APPROVATO ANDREA C.		21/12/2023				
N.	DATA	DESCRIZIONE	FIRMA	TOLLERANZE		MISURE	ANGOLI NON QUOTATI	SCALA	FORMATO	FOGLIO
/	/	/		ISO 2768 mK		mm	90°	1:10	A3	3 / 4

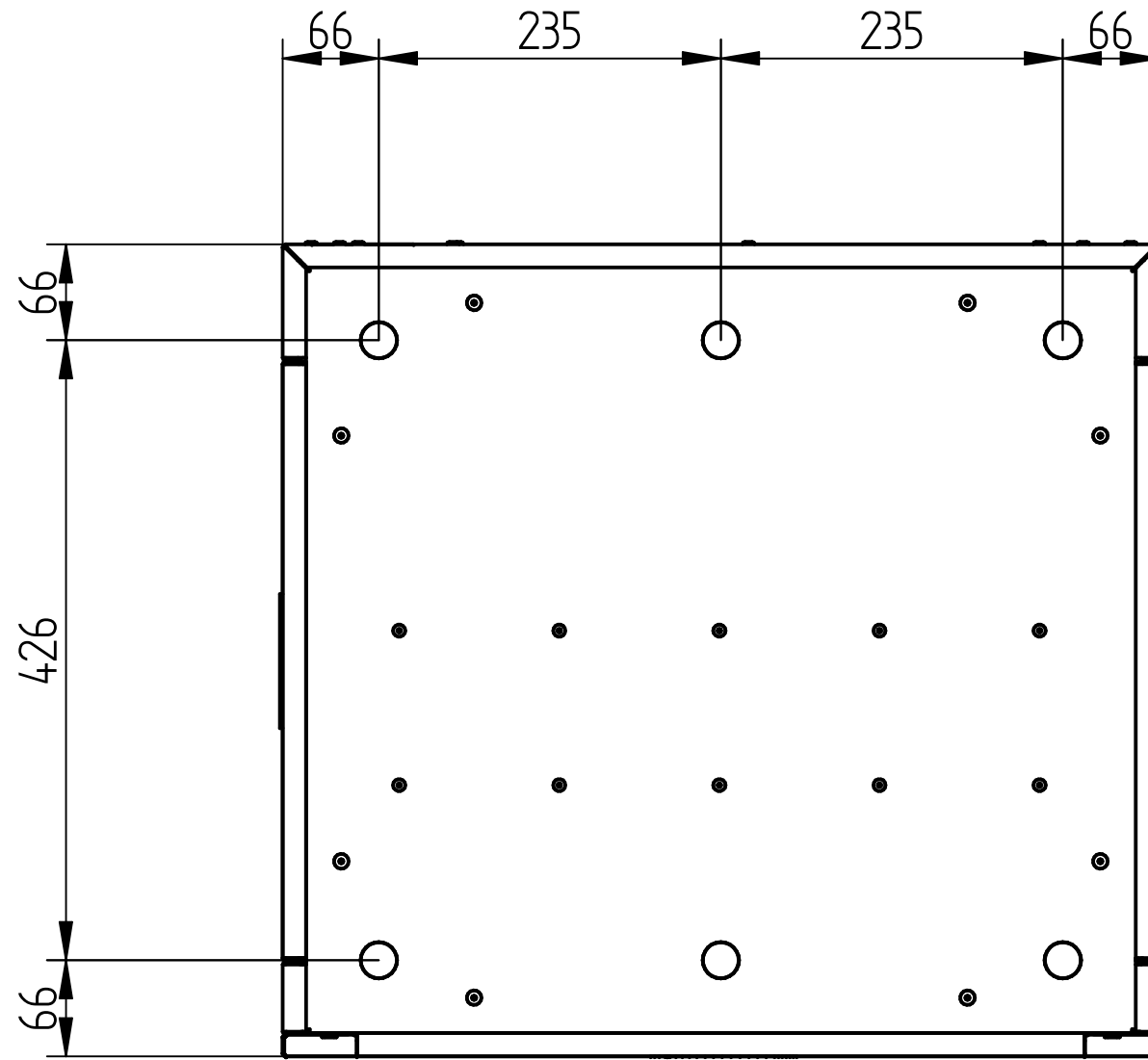

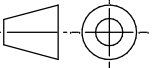
										 Thermics energie www.thermics-energie.it E-mail: info@thermics-energie.it	
										DESCRIZIONE Dimensionali DURAN 8-12 kW_4TS_UI_Rev.05	
										CODICE 7T03xx4M2xx05	
										REV 05	
										NOME PUPPO L.	
										DATA 21/12/2023	
										APPROVATO /	
										DATA 21/12/2023	
											
N.	DATA	DESCRIZIONE		FIRMA		APPROVATO					
	V / Ph / Hz	ATTACCHI	REFRIGERANTE	TOLLERANZE	MISURE	ANGOLI NON QUOTATI	SCALA	FORMATO	FOGLIO		
	230 / 1 / 50	/	R410a	ISO 2768 mK	mm	90°	1:5	A3	4 / 4		